

Exercise 1

UV/Vis spectra allow for the fast and easy calculations of extinction coefficients as well as the interpretation of different electronic transitions of the molecule.

a) The UV-Vis spectra of the thio amide is shown below in grey. Assuming the spectrum was recorded using a 1 mm quartz cuvette with a concentration of 0.5 mM, calculate the extinction coefficient for the compound at 272 and 332 nm. The absorbance for the compound at 272 nm is 0.4567 and the absorbance at 332 nm is 0.4264.

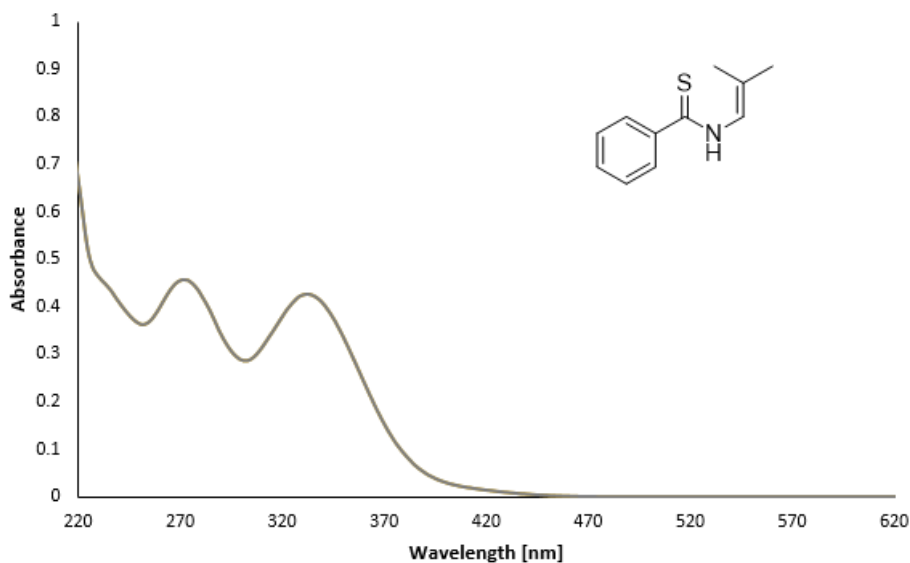

b) The enone shown below shows phosphorescence at $\lambda = 410$ nm. Calculate the triplet energy.

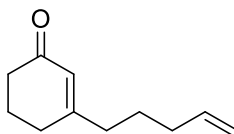

c) Using a Jablonski diagram, qualitatively explain why one observes fluorescence at lower wavelengths compared to phosphorescence (no mathematics required).

d) The enone shown above is reported to undergo rapid intersystem crossing to the triplet state (T_1) when the $n\pi^*$ transition is excited at 320 nm. Explain what causes intersystem crossing for the above enone.

Exercise 2

a) In the total synthesis of Zaragozic acid C, a photochemical C-H activation was utilized as the key step for the construction of the first bicyclic structure with high regio- and stereoselectivity. Why is the choice of the light source (visible light) crucial for the success of this transformation (*Hint*: consider the UV/Vis absorption properties of the molecules involved)? Make a suggestion for a suitable model that explains the stereoselectivity and analyze the observed regioselectivity (C4 over C6). What is the name of this reaction? Explain the formation of the product by drawing all intermediates.

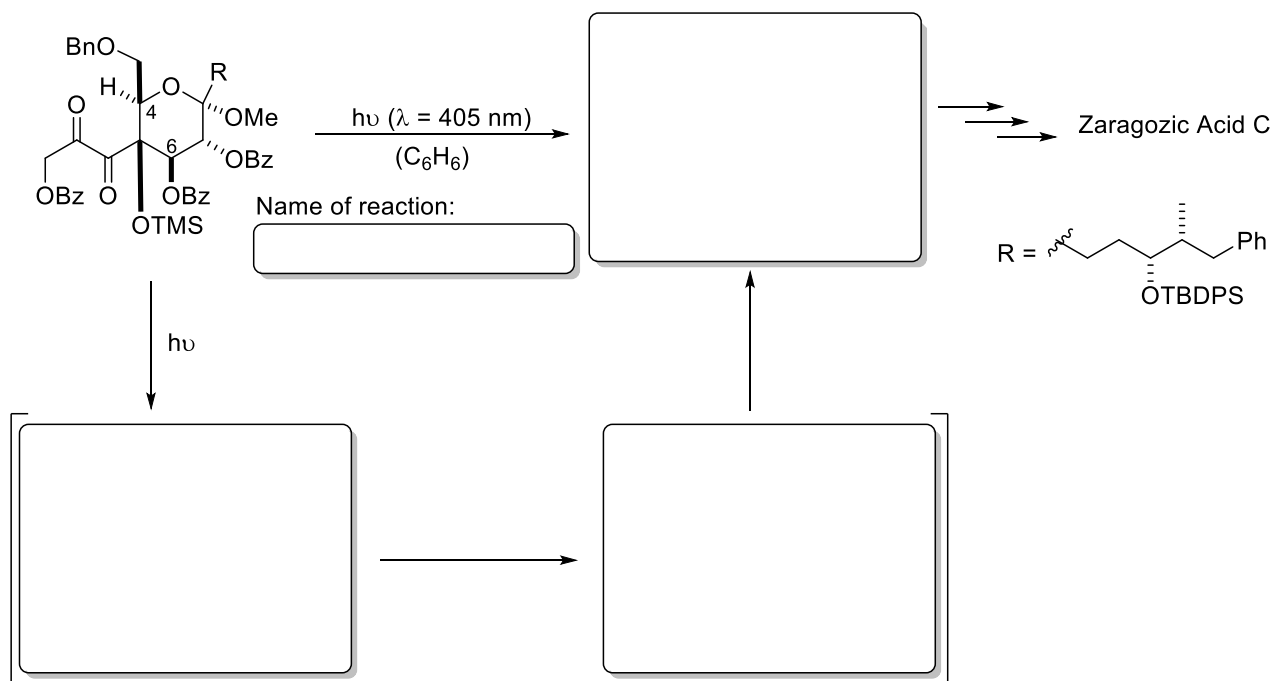

b) Many monocyclic terpenes can be found as natural products in different plants and are often used as fragrances in detergents or cosmetics and perfumes. Especially in the latter case, it is important to prevent premature volatilization to avoid the loss of the fragrance effects. One solution is the application of so-called pro-perfumes, where the fragrance can be released by cleaving a covalent bond which can be induced e.g. by a photochemical reaction. What are the products of the Norrish type 2 cleavage in the reaction stated below (that are formed with 15% yield), and what is the product of the competing intramolecular photoreaction (formed with 45% yield)? Explain also how a Norrish type 1 cleavage could occur.

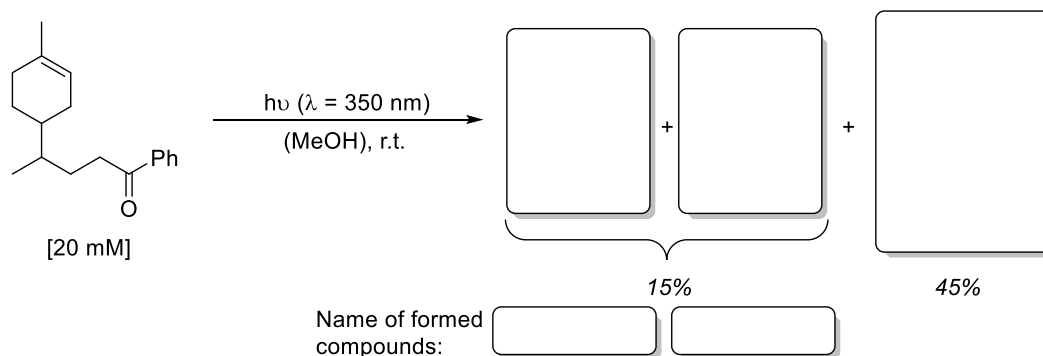

Exercise 1

A key step in the total synthesis of (±)-herbertenolide involves irradiation of a powdered sample of cyclohexanone derivative **A** in the solid state. Which product is formed in the photoreaction? What is the name of this type of reaction? How does the last step proceeds mechanistically?

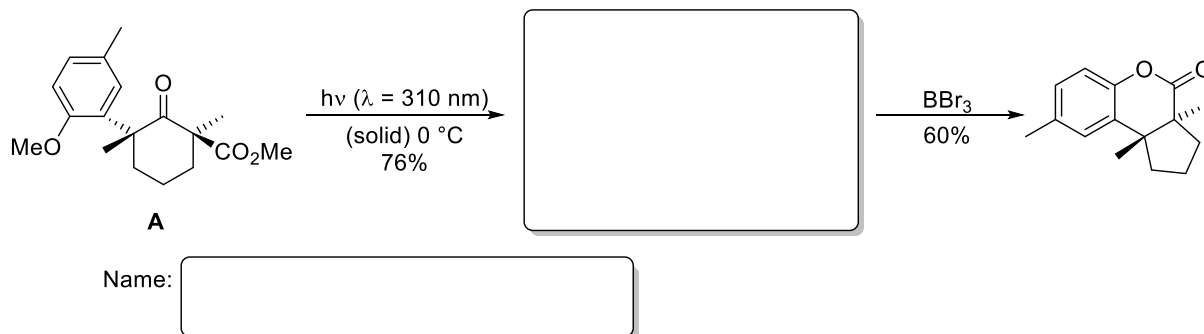
**Exercise 2**

a) Upon excitation of starting material **A** with a black LED light and subsequent intersystem crossing, highly reactive enol intermediates are generated. Only one of the intermediates (**B** or **C**?) can be trapped in an intermolecular reaction with compound **D** to give the benzocyclohexanol derivative **E** in high yield. Complete the scheme given below (including intermediates and electron arrows) and explain the diastereoselectivity of the final reaction step.

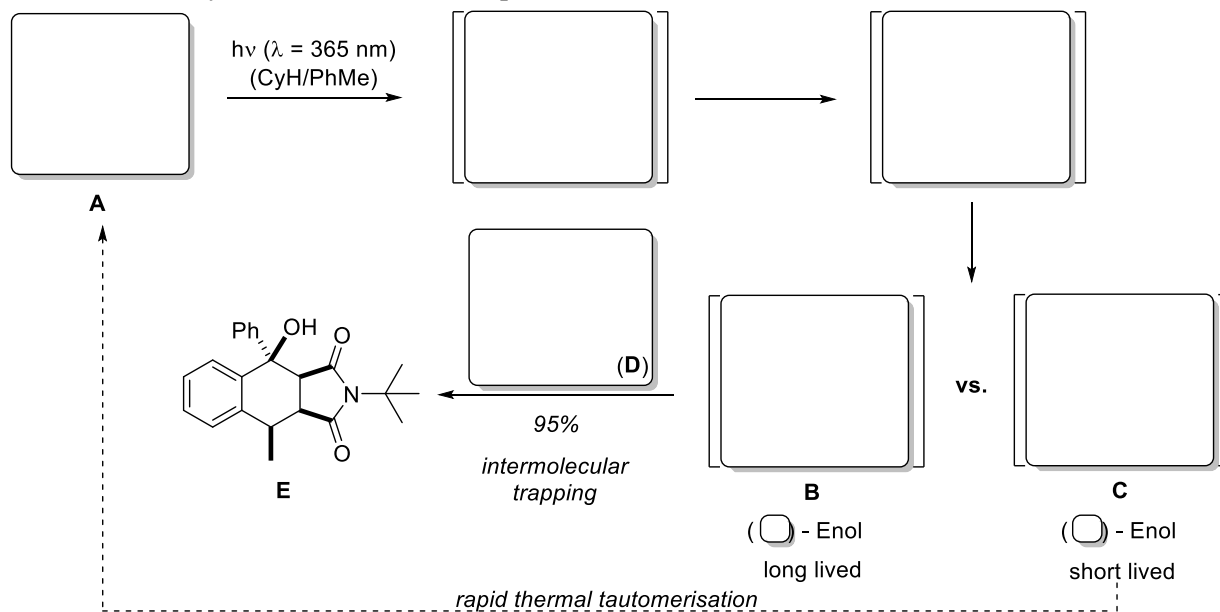

b) Give the intermediate and the product of the photochemical transformation of ester **A** and explain the regioselectivity by employing a suitable model. How can the starting material **A** be obtained in a simple two-step sequence starting from the given cyclohexanone **B**?

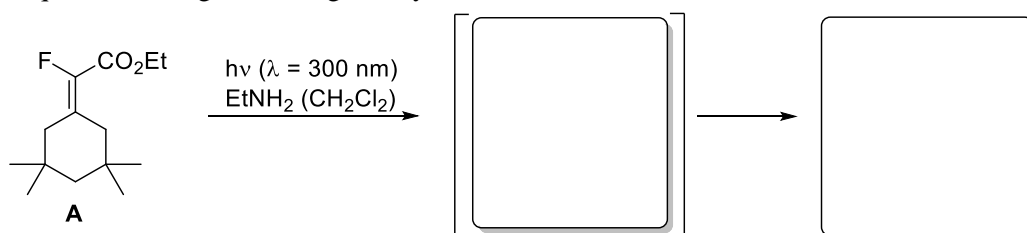

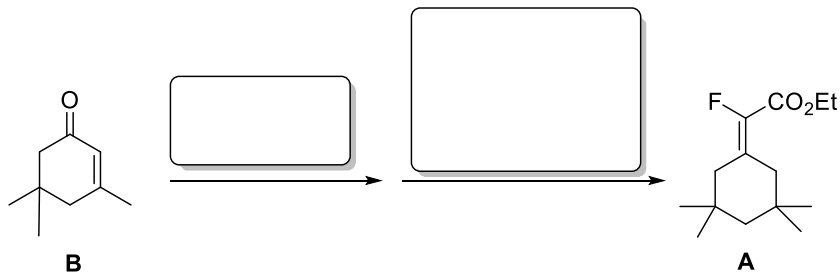

Exercise 3

a) Benzaldehyde is irradiated in the presence of a chiral alkene leading to the formation of two stereoisomeric products. Give the structure of the two stereoisomers and describe the mechanism of the formation of the major diastereoisomer.

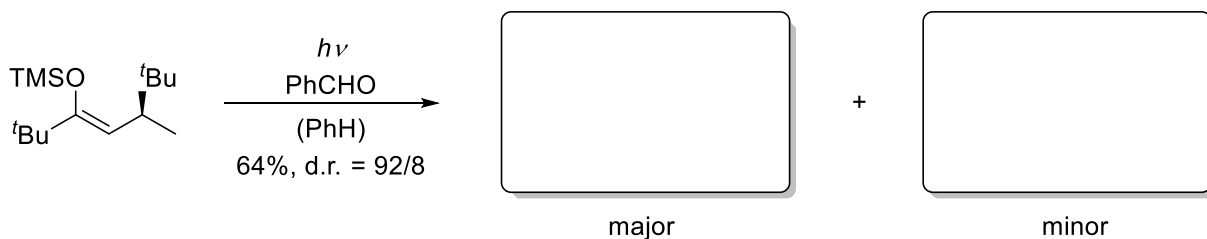

Mechanism (major diastereoisomer formation:

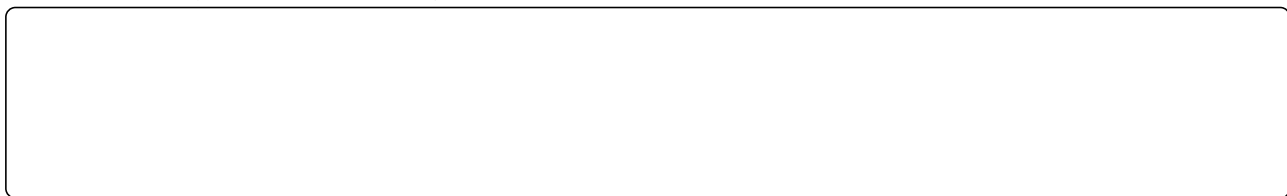

b) Give the reaction product with expected stereochemistry in the following *Paternò-Büchi* reaction.

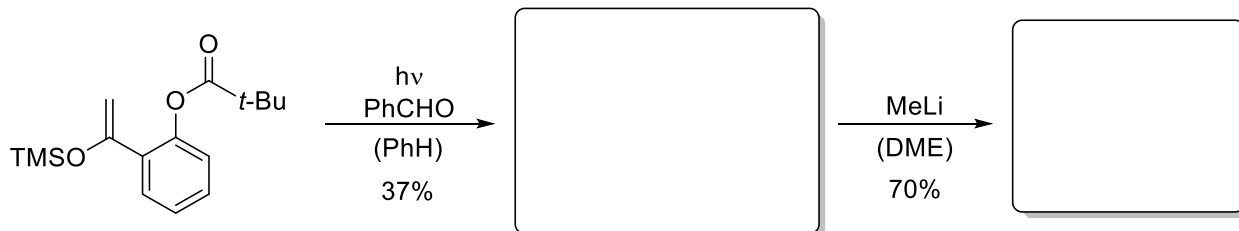

c) As already stated, *Paternò-Büchi* products allow for further functionalization. Give the products of the following ring opening reactions and explain the regioselectivity.

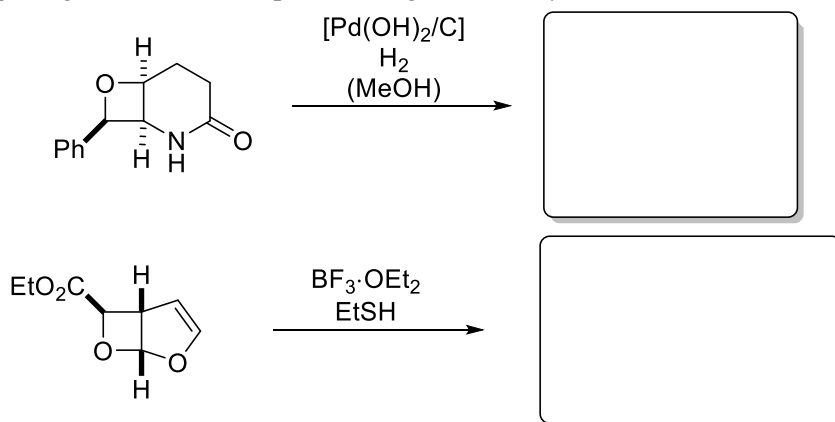

Exercise 1

a) Draw the product of the [2+2] photocycloaddition reactions shown below and explain the regio- and diastereoselectivity.

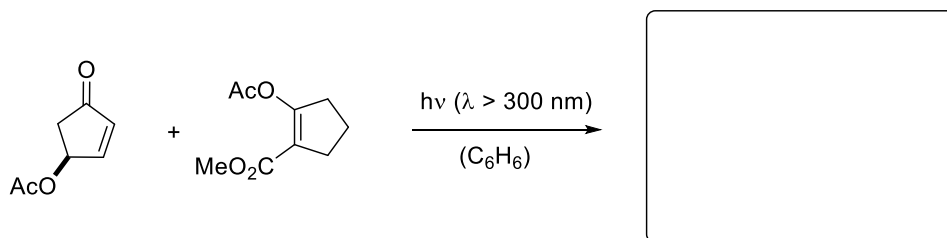

Hint: Allenes react similar to acceptor-substituted olefins

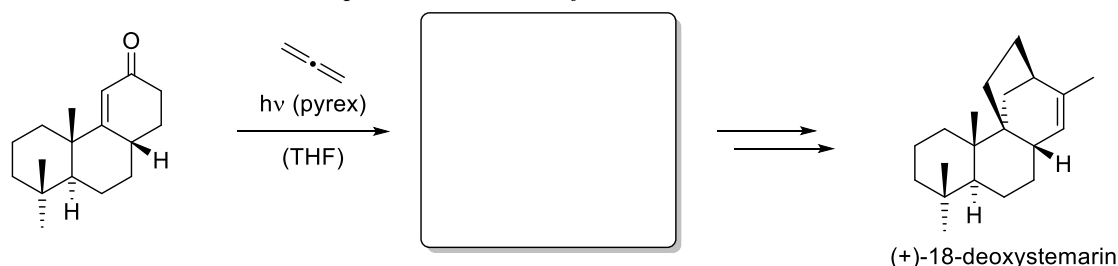

b) The total synthesis of (±)-hirsutene starts with a photochemical key step. Draw the product of this transformation and state the name of the reaction sequence. Also fill in the missing reagents and give the name of the reactions that lead to the final natural product.

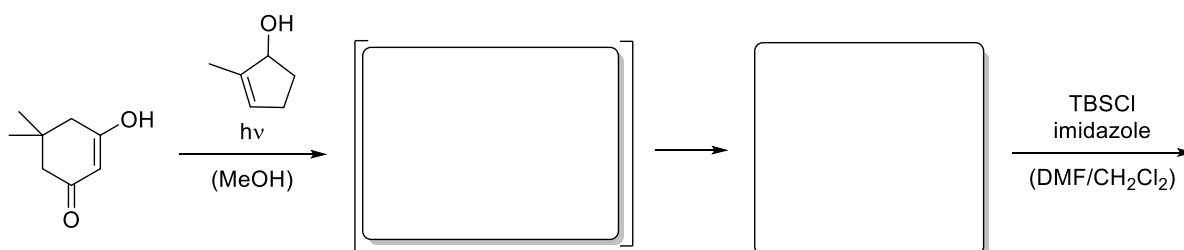

name of the reaction sequence:

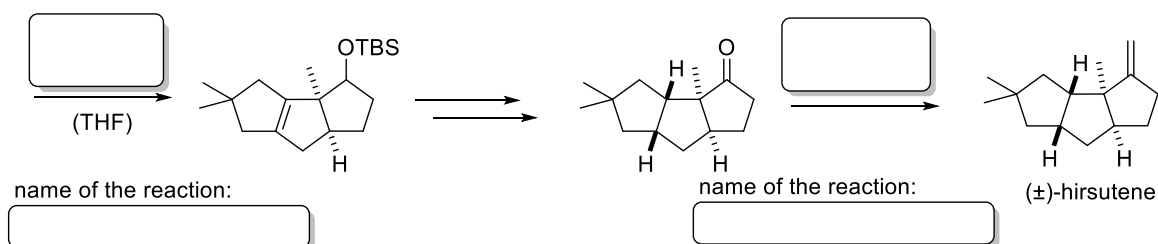

name of the reaction:

name of the reaction:

Exercise 2

a) UV irradiation of cyclic enones and nitrogen heterocycles lead to the formation of 1,4-adducts. Samples that were not exposed to UV irradiation showed no conversion. Complete the following synthesis and propose a structure for the intermediate.

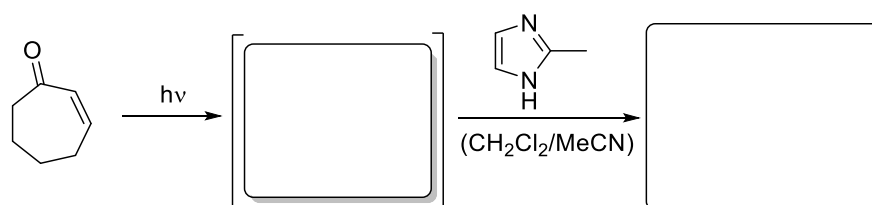

b) The depicted cyclic enone does not undergo a reaction without irradiation. Upon irradiation a reactive intermediate leads to a *Diels-Alder* reaction. Explain this observation and please fill in the blanks.

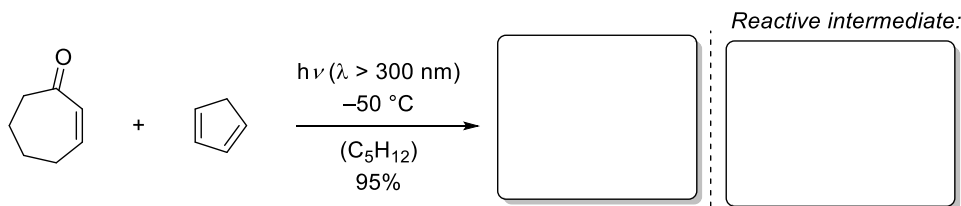

Exercise 3

a) Anthrylethylene derivatives undergo *E/Z* isomerisation upon irradiation. Irradiation at a wavelength of $\lambda \geq 400$ nm applied to a solution in hexane yields photostationary ratio of *E/Z* = 6:94. Explain this selectivity considering the following UV/Vis spectra.

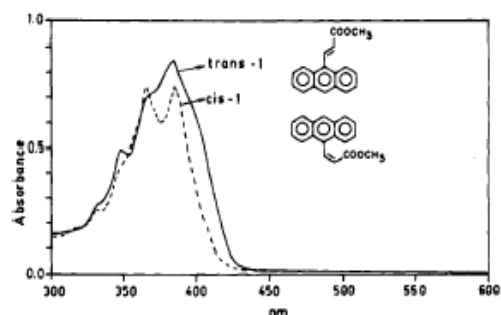
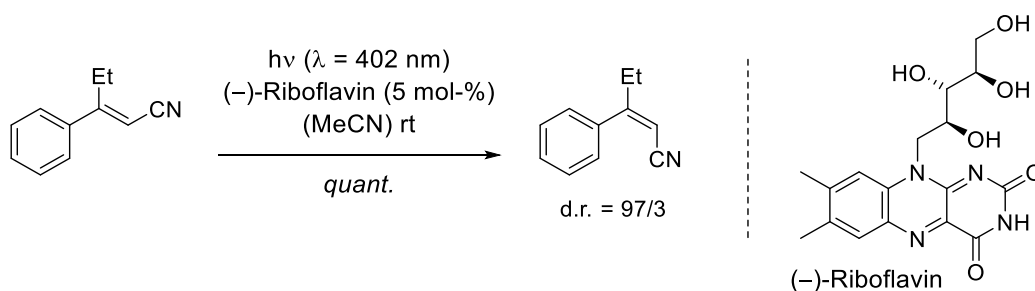

Figure 2. UV-vis absorption spectra of *trans*-1 (solid line) and *cis*-1 (broken line) in hexane solvent.

b) The following photocatalytic *E/Z* isomerisation of cinnamionitriles in the presence of (–)-Riboflavin was observed. Explain this phenomenon by drawing a rough scheme of the possible energy distribution of the electronic states involved in the reaction.



Exercise 4

Benzaldehyde is irradiated in the presence of a chiral alkene. Give the major product. Explain the formation of this product.

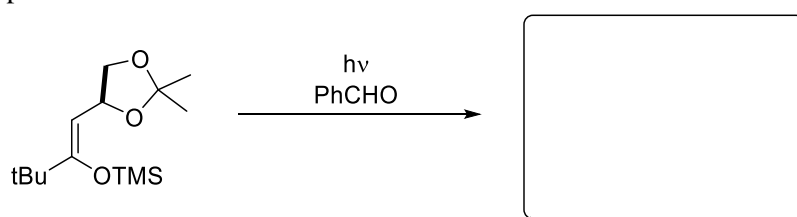

Mechanism:

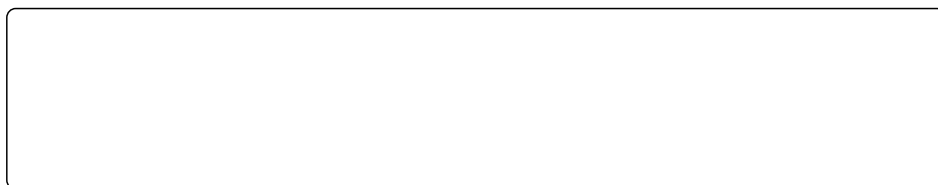

Exercise 1

The following intramolecular [2+2] photocycloaddition reactions could be achieved in high yields and stereoselectivity. Give the photoproducts and explain the diastereoselectivity with a suitable model.

a) Fill in the missing condition in the first case. Give a suggestion which wavelength you would need for the Cu-catalyzed reaction. What is the oxidation number of the reactive Cu complex?

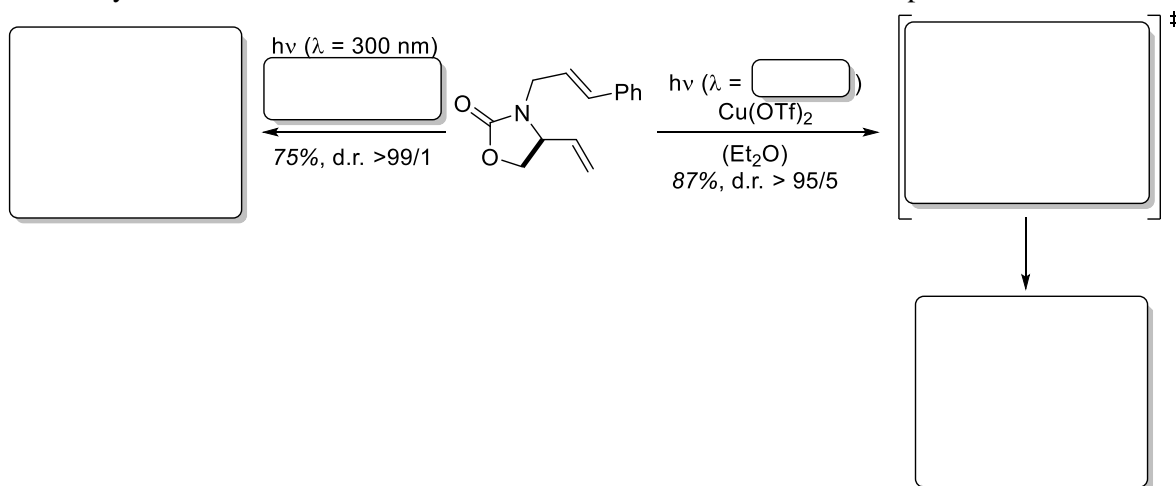

b)

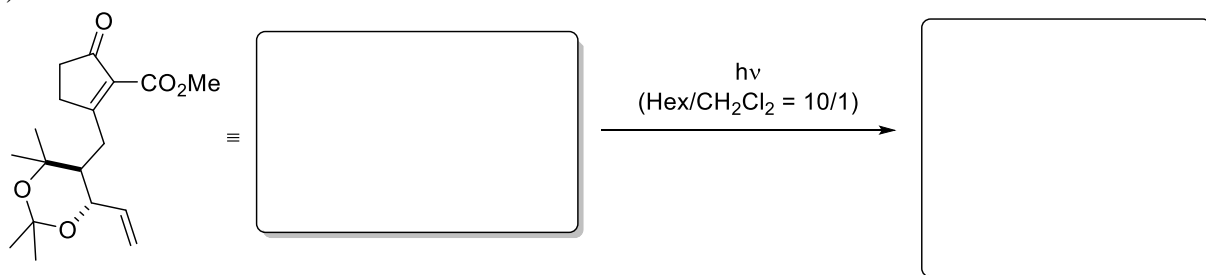

c) *Hint: chiral induction does not occur from a stereogenic center at the furan moiety.*

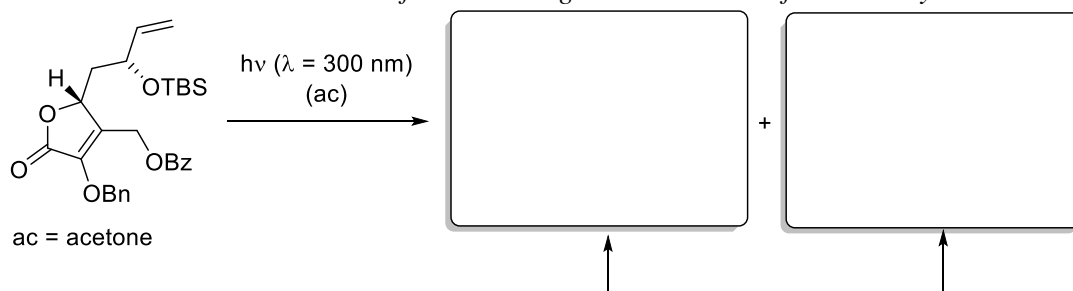

via:

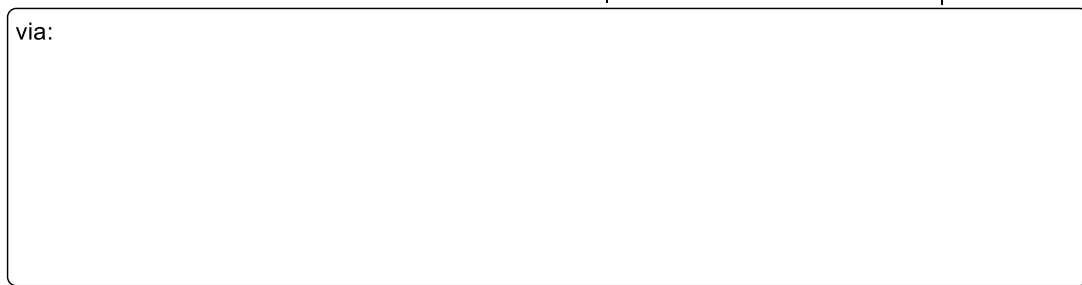

Exercise 2

(-)-Silphiperfol-6-en-5-one was synthetically accessible by using an oxadi- π -methane rearrangement. Draw the product and the appropriate intermediates of the photoreaction. Fill in all missing structures of the depicted thermal reactions. *Hint: In the fourth reaction shown below, one of the C-C-bond will be cleaved.*

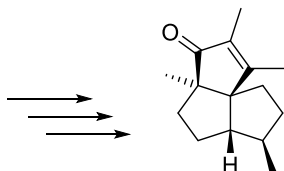
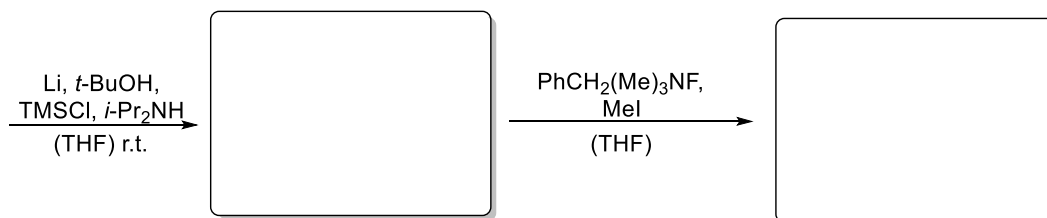
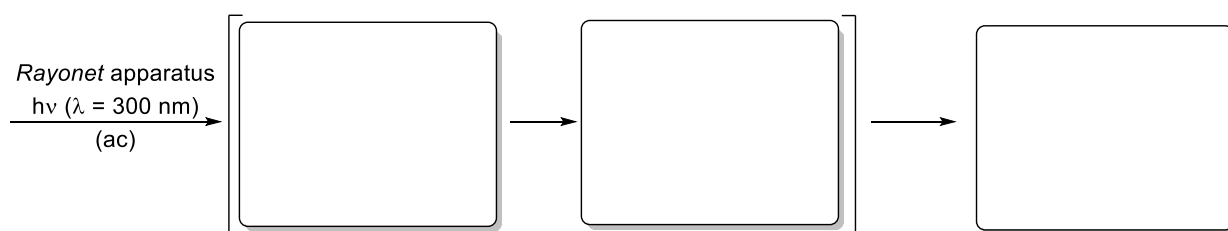
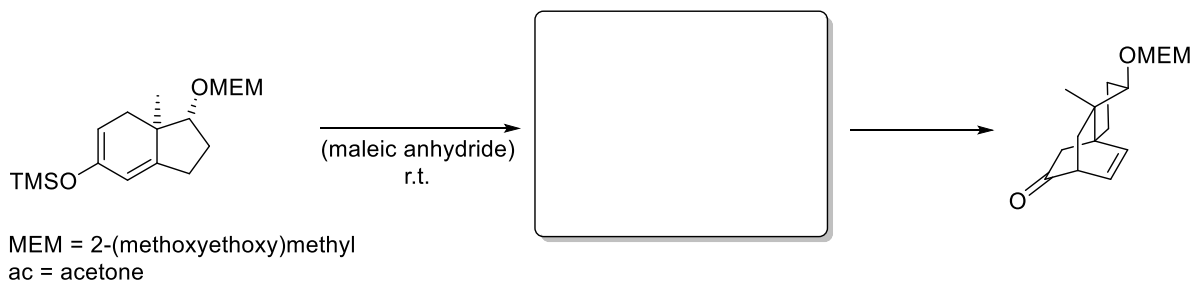

(-)-silphiperfol-6-en-5-one

Exercise 3

Explain the mechanism of this photochemical rearrangement by drawing the important radical intermediates.

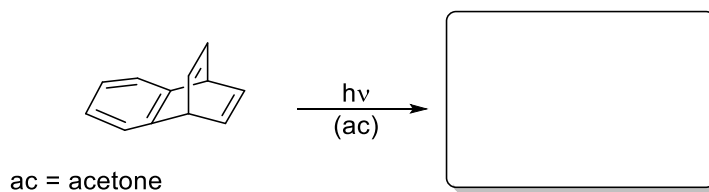

via

Exercise 1

Draw the structure of the following oxa-di- π -methane rearrangement product in the correct relative configuration!

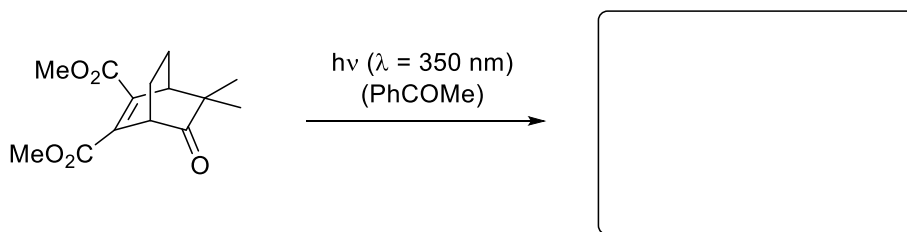

Exercise 2

The shown bicyclo[3.2.1]oct-6-en-2-one was irradiated with a high-pressure mercury lamp through a Pyrex filter. Which product do you expect?

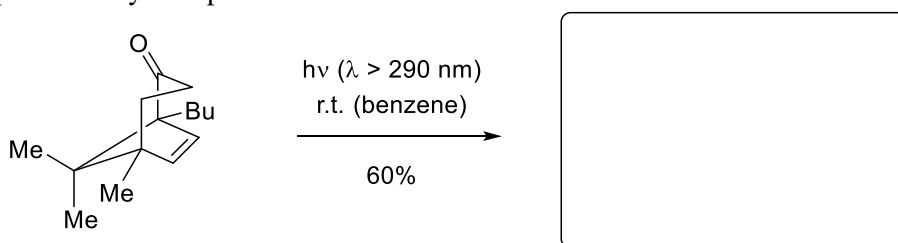

Exercise 3

In the sequence below a simple phenyl ketone was used to obtain the tricyclic product in a regio- and stereoselective manner. Fill in the missing starting material and intermediate and name the type of reaction.

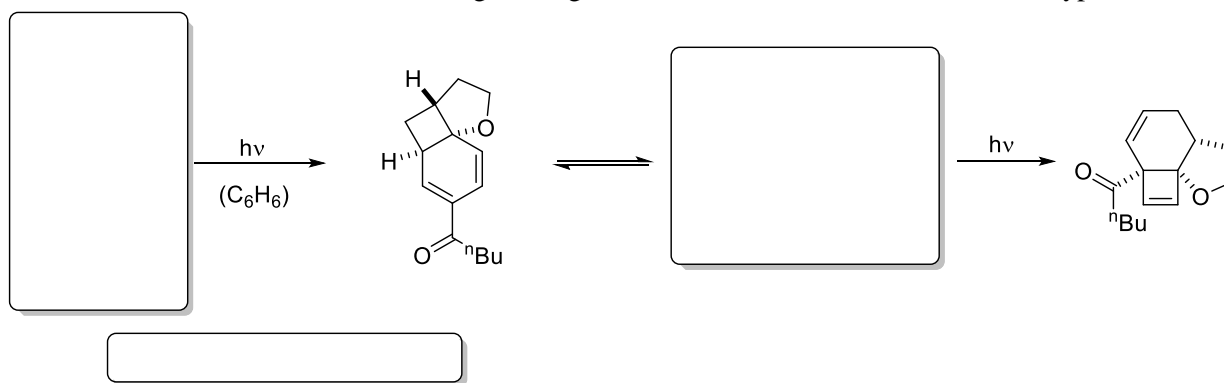

Exercise 4

a) In the total synthesis of (\pm)-crinan, the tetracyclic core structure was built by a 6π cyclisation of the benzoic amide stated below. Give the intermediate and the product of this transformation with the correct relative configuration. What kind of reaction occurs in the second step? In addition, classify this reaction according to the *Woodward-Hoffmann* notation.

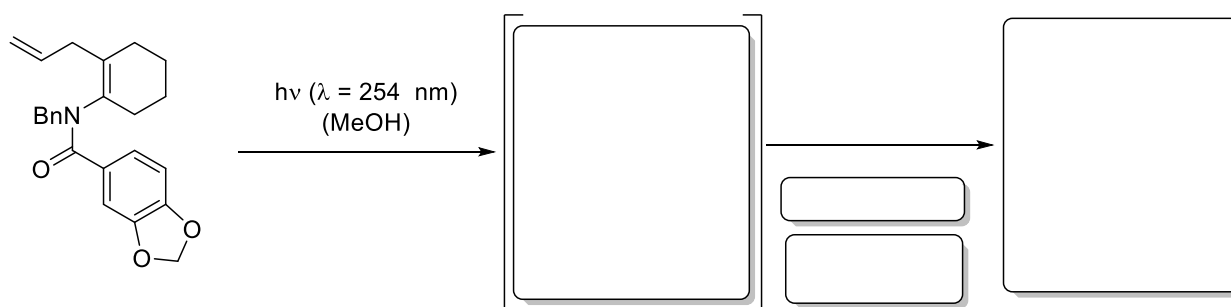

b) A photochemical cyclisation was employed in the total synthesis of (\pm)-*cis*-alpinine to build up the benzindenoazepine core structure through an acid-mediated ring opening of the intermediate aziridine. Complete the reaction sequence and state, if the cyclisation proceeds in a conrotatory or disrotatory fashion.

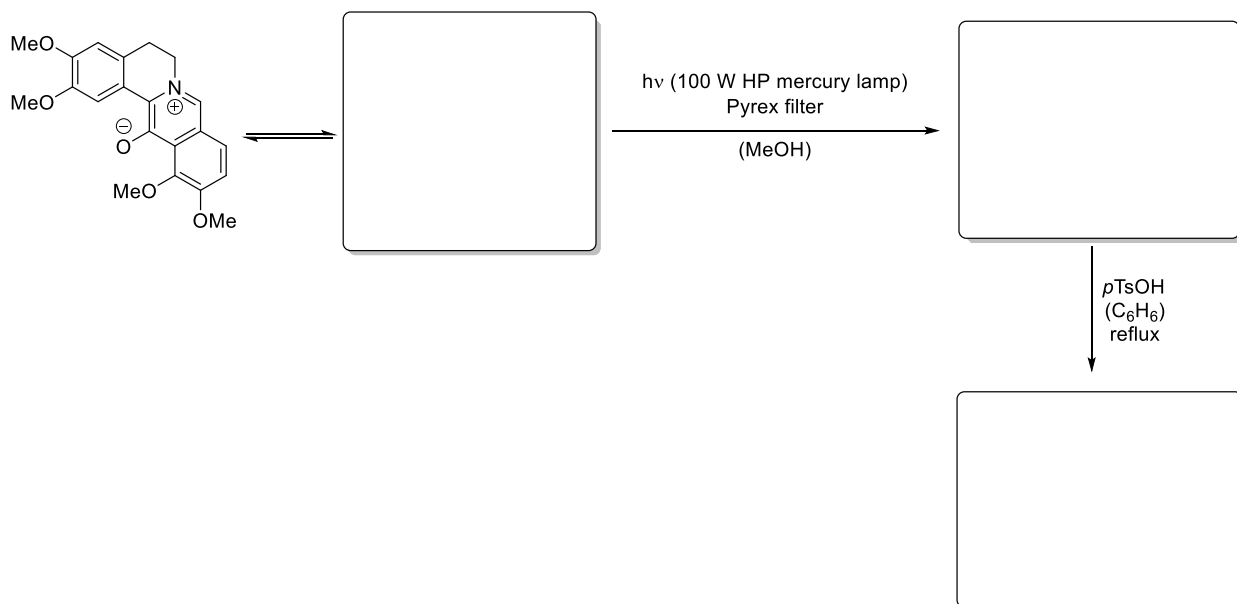

Exercise 5

Upon irradiation, the allyl anion may cyclize to the cyclopropyl anion as depicted in the scheme below.

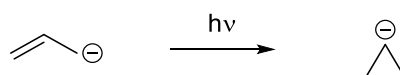

To analyze the reaction, draw the molecular orbitals of the starting material and the corresponding orbitals in the product. Determine if they are symmetric (S) or antisymmetric (A) regarding the symmetry operation of a conrotatory ring closure (C_2 axis). How many electrons occupy the symmetric and antisymmetric molecular orbitals in the starting material and in the product in the first excited singlet state? Is the conrotatory ring closure photochemically allowed? Justify your decision.

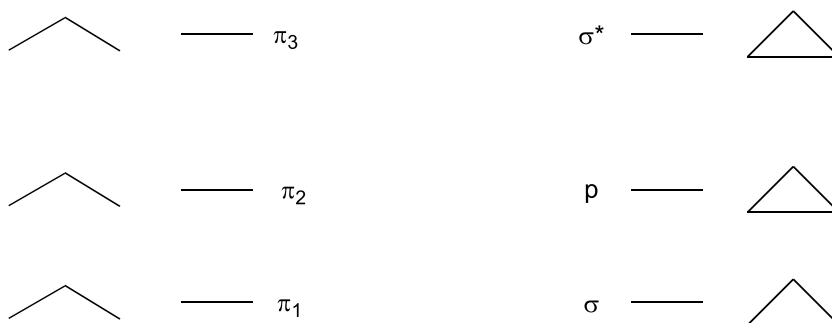

Exercise 1

Enantioselective photocycloadditions are a major research topic in recent studies. One opportunity for enantioselective photocycloaddition is the reaction with a chiral organocatalyst.

Draw the hydrogen bond complex of the substrate and the catalyst and the preferred enantiomer of the product. Determine the configuration of the new formed stereogenic centre on the α -carbon atom according to the *Cahn-Ingold-Prelog* sequence rules (CIP priority rules).

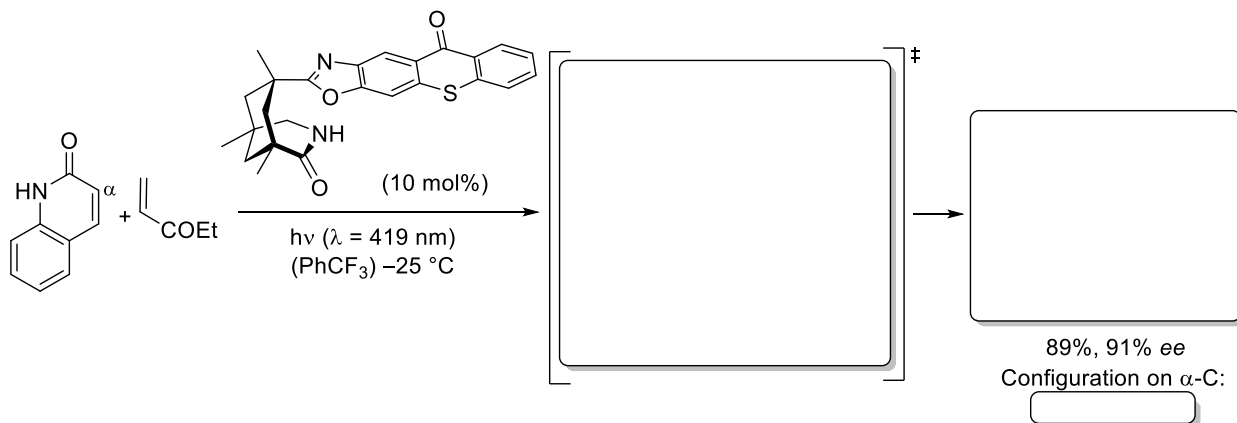

b) The used chiral catalyst has a sensitizer as shield. What is the sensitizer? Please draw the structure of the sensitizer and explain briefly the principle of a sensitized photoreaction.

Exercise 2

Below you can see the retrosynthetic scheme of the total synthesis of hybocarpone. The natural product could be obtained by a sequence containing one photochemical reaction starting from benzaldehyde **A**. What is the name of this photochemical reaction? Which further transformation is necessary to obtain the shown ketone **B**? Give these two reactions and make a suggestion for the reaction conditions to make ketone **B**.

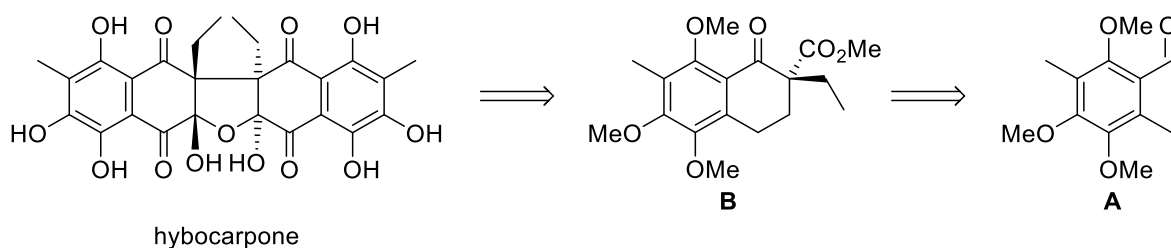

Exercise 3

Determine whether the following reaction would proceed via an *ortho*- or *meta*-photocycloaddition and draw the product.

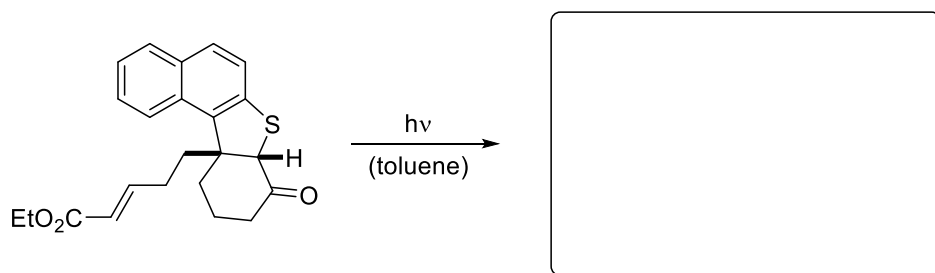

Exercise 4

Photocycloadditions of aromatic compounds lead to dearomatization. Fill in the missing product.

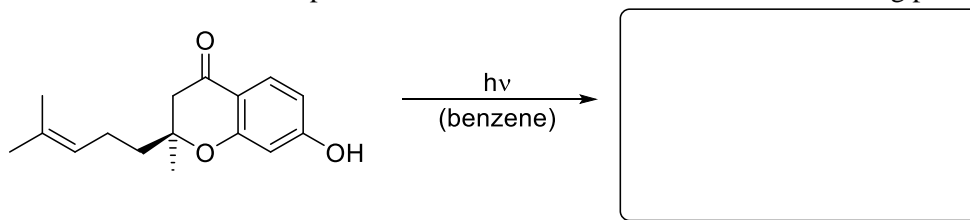

Exercise 5

The following photoreaction was used towards the total synthesis of retigeranic acid, a sesterterpene monocarboxylic acid. Draw the product and name the type of reaction.

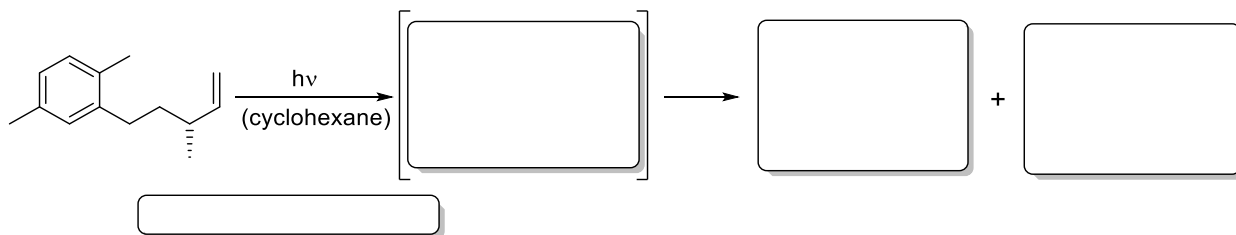

Short repetition

Fill in all missing intermediates and products.

a) *Hint: LDBB (lithium di-tert-butyl-biphenylide) is a single electron donor!*

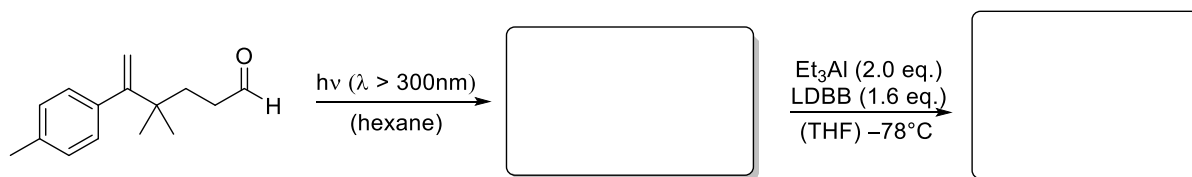

b)

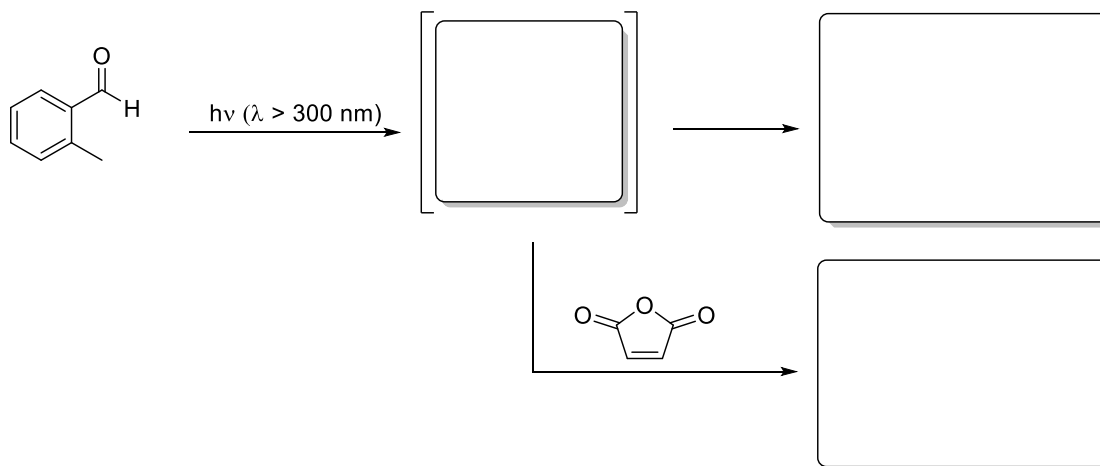

c) *Hint: in this case, the inner double bond of the allene reacts.*

